

EXAMION®

X-Ray Systems · Digital Imaging · Service

X-DRS Floor Z-Arm

Swivel bracket systems with detector



Swivel bracket

The EXAMION swivel bracket systems are among the most compact and space-saving X-ray systems and are therefore ideal for small rooms and low ceilings.

The system can particularly easily be positioned for upright images since the X-ray source and bucky tray are coupled via the transverse arm and can be brought to the desired height together.

Thanks to the hinged transverse arm of the swivel bracket, both prone and upright images can be taken with a single bucky tray. It is also possible to place the transverse arm in intermediate positions for inclined images. The main advantage of systems with a single bucky tray is that the detector usually does not have to be removed and is therefore optimally protected. When other X-ray systems are combined with just one detector, it is placed alternately in the table and the wall unit. The swivel bracket is the ideal solution if you want to work with just one detector to optimise acquisition costs.

Your competent partner for X-ray systems

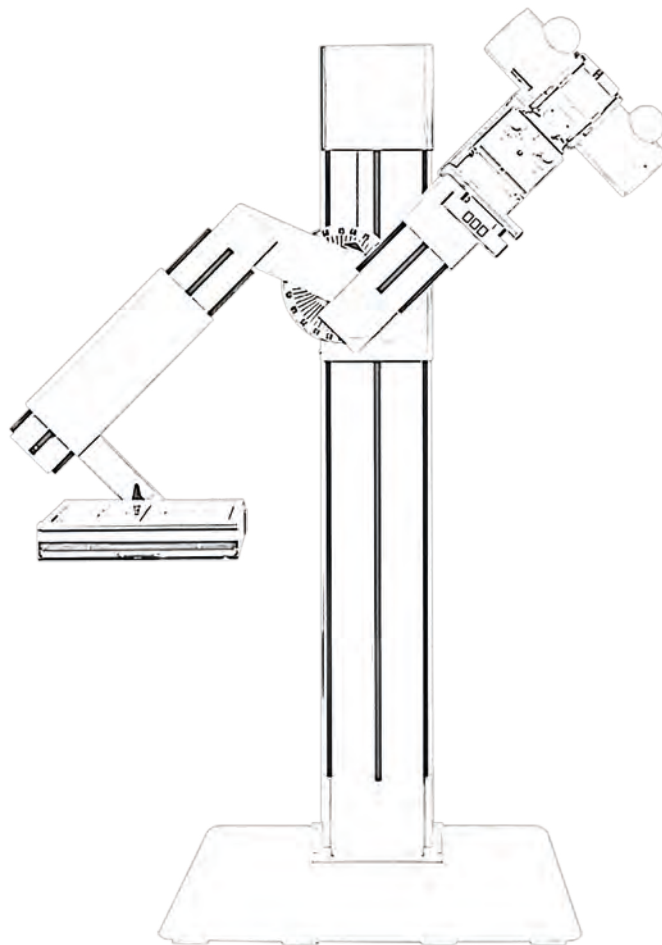

Swivel bracket

-DRS Floor Z-Arm

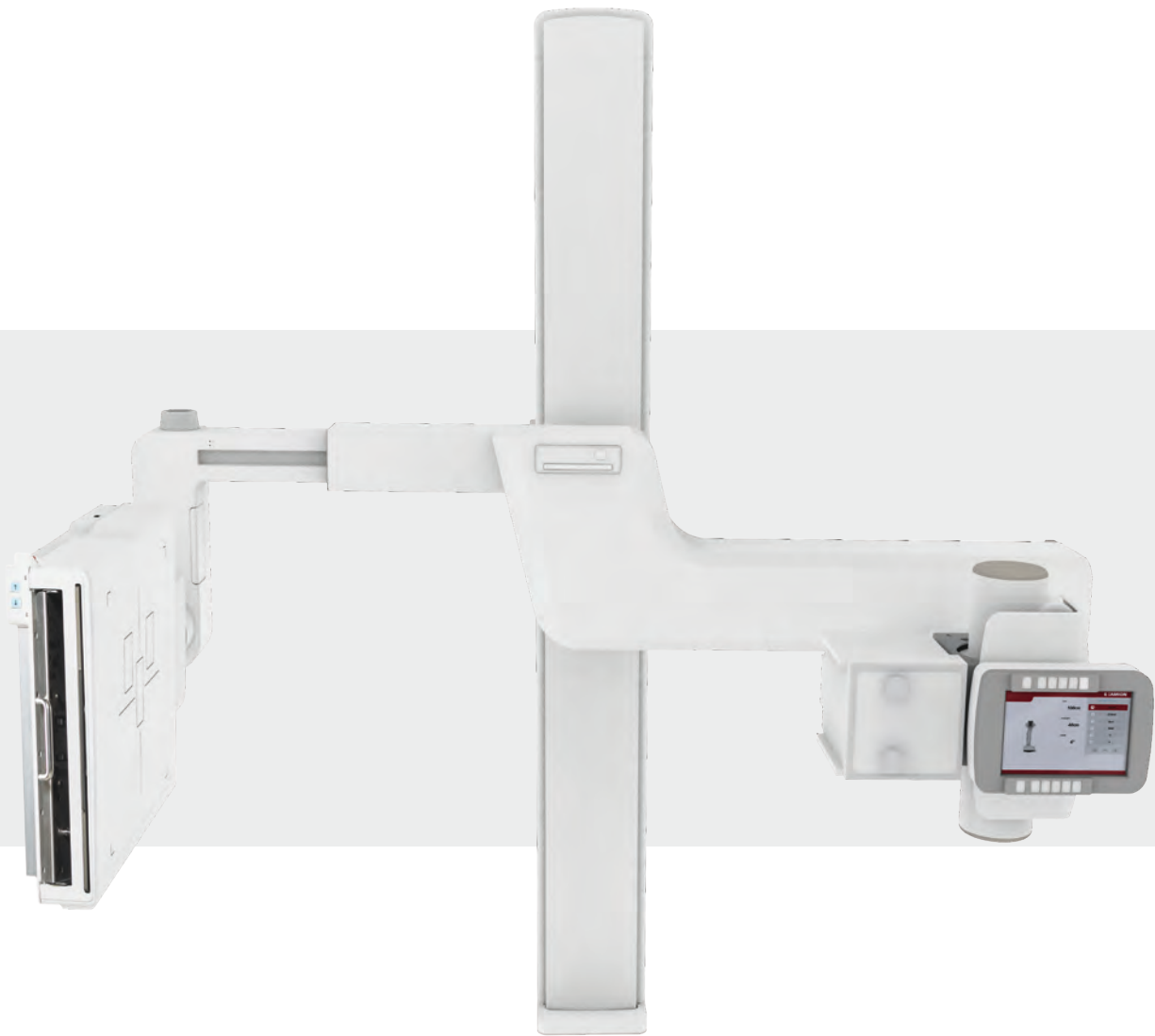



Fully motorised X-ray system for all common applications

The X-DRS Floor Z-Arm swivel bracket is designed for ease of use in every respect. It is fully motorised – not a single movement needs to be performed mechanically. As a result, the X-DRS Floor Z-Arm also offers a comfortable stitching option.

Areas of use

In medical practices and medical care centres which need to take high numbers of X-rays every day, the physically challenging settings can be highly stressful for operators. Here, the motorised X-DRS Floor Z-arm can provide significant improvement.

X-DRS Floor Z-Arm



Private practices



MVZ

Optimal price-performance relation

The motorised swivel bracket system supports the user in a wide range of ways; the comfort, measured against purely mechanically acting X-ray systems, is evident from the very first minute. This results in a slightly higher purchase price, which EXAMION counters by standardising components as much as possible. This enables us to offer a very comfortable system at an very attractive price.

Comfortable X-ray system with many setting options

Intuitive and easy placement

The system offers a particularly high level of support for users who operate the X-ray system without interruption and over a long period of time and who frequently have to take oblique images.

The system can be positioned comfortably simply by pressing a button. Stored positions can be selected on the touch screen, and even the rotation of the buckytray is included. This means that positions for oblique exposures can also be saved and called up at the click of a button. The level of efficiency in your surgery is significantly increased.



Full-leg photography - very simple with stitching

With the optionally available stitching variant of the X-DRS Floor Z-arm, not only is the cross arm moved into different positions, but the cross arm and detector are each rotated so that the individual ray points all begin from the same source. This is the only way to achieve an optimal overlapping of the individual images.

Synchronisation:

- Automatic positioning of the unit based on the system's organ programmes
- X-ray source and bucky tray are directly connected to each other and are thus centered
- Stitching option: Automated tracking of the positions for the required partial exposures





Technical specifications

X-ray stand

SID	100 cm - 180 cm Motoric movement
Height adjustment	Min. 40 cm Max. 170 cm Motoric movement
Rotation angle cross arm	- 30° - 120° Motoric movement
Spotlight rotation angle	± 90°
Rotation angle Bucky	± 45° Motoric movement
Control system	10" Touch Screen
Bucky	For CR cassettes and mobile detectors in cassette format

Further specifications

Generator	CPI CMP 200 DR, 50 kW, max. 630 mA, max. 150 kV, AEC, manual switch, 3 Phasen / N / PE, 400 V, incl. console Other generators on request
Tube	Varex RAD-14, Fokus 0,6 / 1,2 mm, 300 kHu, max. 150 kV, incl. high voltage cable, weight 17,4 kg Optional: RAD 21, RAD 60
Collimator	Manual rotatable, LED-lamp, integrated timer, Laser adjustment
AEC	3-field measurement chamber with cable
DFP (optional)	Measure dosage Area Product or DFP calculation, automatic integration into the X-AQS X-ray journal
Warranty	5 year warranty on detectors 1 year warranty on all other components Extended warranty on request
Certification	CE 2460

Swivel bracket

-DRS Floor Z-Arm Manual





Digital X-ray in a small space – without restrictions

The X-DRS Floor Z-Arm Manual consists of a mechanically adjustable swivel bracket X-ray system combined with the high-quality EXAMION detectors as well as the X-ray software X-AQS. The system was specially developed as a space-saving solution when treating emergency and intensive care patients who need to be examined while lying down.

Areas of use

Not only does the far-reaching mobility of the cross arm expand the possible field of use, but its low demands on the installation space also make the X-DRS Floor Z-Arm Manual the perfect choice for X-rays in extreme situations, for example in emergency containers.

X-DRS Floor Z-Arm Manual



Resident doctors



MVZ



Emergency Container

Expanding the application possibilities

The X-DRS Floor Z-Arm Manual is a robust X-ray system that offers a simple way to perform all standard X-ray examinations. In addition, this X-ray system can also be used to take lateral exposures on the X-ray table. For this procedure, the patient table is moved through the centre of the Z-shaped opening of the transversal arm in front of the tray. The classic application of the Z-arm is lateral chest radiographs of intensive care and trauma patients who are in a supine position.

Flexibly usable X-ray system

Dependable - even in extreme situations

The system is ideally suited for small hospitals in outlying regions, field hospitals, container hospitals and for installation in a truck. Even in such unusual places, X-ray images are often indispensable for diagnosis in order to enable correct treatment of patients. Here, the space-saving X-DRS Floor Z-arm proves to be a reliable support and facilitates the examination for the user.

Due to the mechanical system, the swivel arm is extremely reliable. The X-DRS Floor Z-Arm Manual ensures a high level of fail-safety and you can be sure that X-ray examinations can proceed continuously in your practice or in extreme situations. In addition, the components of the X-DRS Floor Z-Arm are especially designed for durability, so that the system will support you in your daily practice for a long time.



System positioning - made easy

The smooth mechanical movements allow the system to be positioned extremely quickly. Changing between lying and standing images by turning the cross-arm, adjusting the cross-arm height for standing images and changing the source image distance can be done very quickly with the appropriate routine - faster than would be the case with a motorised system. New staff do not need extensive training, and they can acquire the experience needed for positioning in a very short time.

Synchronisation

The X-ray tube and the bucky tray are directly connected to each other via the cross arm. Thus they are moved together at the same time and remain centred to each other. The operator no longer has to check that the focus corresponds individually. This additional work step is no longer necessary which is easier for the operating personal.





Technical specifications

X-ray stand

SID	110 cm ~ 200 cm
Height	218 cm
Height adjustment (electromagnetic locking)	Min. 33 cm Max. 167 cm
Cross arm	Rotatable - 30° bis + 135°, Oblique images possible, electromagnetic locking
Bucky unit	Rotatable ± 45°
Spotlight unit	Rotatable - 90° bis + 180°
Weight	Ca. 310 kg (incl. tube, depth aperture and bucky)
Legal requirements and standards	CE 2460

Further specifications

Generator	CPI CMP 200 DR, 50 kW, max. 630 mA, max. 150 kV, AEC, Manual switch, 3 Phases / N / PE, 400 V Other generators on request
Tube	Varex RAD-14, Fokus 0,6 / 1,2 mm, 300 kHu, max. 150 kV, incl. high voltage cable, weight 17,4 kg Optional: RAD 21, RAD 60
Collimator	Manual rotatable, LED-lamp, integrated Timer, Laser adjustment
AEC	3-field measurement chamber with cable
DFP (optional)	Measure dosage Area Product or DFP calculation, automatic integration into the X-AQS X-ray journal.
Warranty	5 year warranty on detectors 1 year warranty on all other components Extended warranty on request
Certification	CE 2460

X-DR WiFi – Detectors in a range of sizes

Our detectors are at the heart of the digital X-ray system. They provide high quality X-ray images, saving time and man-hours. They are available in different versions, can be combined with each other and thus cover all requirements without any problems.

Data transfer via WiFi is supported and power can be supplied by a battery. If the detector is permanently installed, the appropriate power supply cabling is available as an option.



X-DR M WiFi TH

- Optimal as a supplementary detector for extremity images
- Suitable for incubators in neonatology
- Size: 23 x 28 cm

X-DR L WiFi und X-DR XL WiFi

- Best seller with excellent price in relation to performance
- Excellent picture quality that also complies with high requirements
- Sizes: 35 cm x 43 cm
43 cm x 43 cm

X-DR L WiFi Premium und X-DR XL WiFi Premium

- Minimal weight
- High protection against liquid infiltration
- Pixel pitch 100 µm: Premium quality X-ray images which meet the highest requirements
- Sizes: 35 cm x 43 cm
43 cm x 43 cm

Our models at a glance

	X-DR M WiFi TH	X-DR L WiFi	X-DR L WiFi Premium	X-DR XL WiFi	X-DR XL WiFi Premium
Pixel pitch	148 µm	150 µm	100 µm	139 µm	100 µm
Pixel matrix	1.920 x 1560	2.304 x 2.800	3.500 x 4.300	3.072 x 3.072	4.267 x 4.267
Weight	1.6 kg	3.4 kg	2.8 kg	4.6 kg	3.4 kg
Size	23 x 28 cm	35 x 43 cm	35 x 43 cm	43 x 43 cm	43 x 43 cm



X-AQS Software – Acquisition, control, archiving

The EXAMION X-AQS software is a universal solution for X-ray image acquisition, processing and archiving, allowing you to control a wide range of CR digitizers, DR flat panels and X-ray generators as well as processes. The software is available as a DICOM modality to connect to your existing image archive, but also as a system solution with X-AQS PACS with standardised operation at viewer workstations. The software can be adapted to your needs and can grow along - always as you need it.



Placing of orders

- Touchscreen operation throughout
- Clear depiction and selection of body regions
- Freely configurable organ lists for each body region

Image acquisition

- State-of-the-art X-AQS image processing
- Consistent user interface and operation steps even when switching between CR and DR systems
- Digital X-ray journal

Post-editing

- Extensive functions for post-editing the image
- Complete diagnostic viewer with measuring tools even at acquisition workstation
- Export in DICOM and other formats via USB stick, DVD or e-mail

Additional features with X-AQS PACS

- Client software for an infinite number of viewer workstations
- Integration of peripherals such as ultrasound, endoscopy, CT and MRT

Webclient

- Full-featured web client not only for image viewing but also, for example, for patient management and order placement

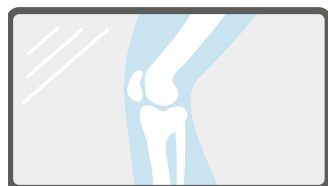

The X-AQS with its user-friendly operating interface is the central controlling unit for digital X-ray. Simple and self-explanatory buttons enable the acquisition of perfect X-ray images with just a few clicks. We offer you a future-proof universal software platform that is constantly being further developed and tested by users.

EXAMION GmbH

EXAMION is a specialised provider of solutions for digital radiography in human and veterinary medicine on the global stage. We have been working for more than 30 years based on the "one stop shop" principle, and support our customers as an expert partner in planning, installation and after-sales service.



Our advice on technical and business matters centres around our customer's needs and practice premises, and each and every offer is individually tailored by our experts.

EXAMION currently services over 7,000 systems, some of these are mobile, but the majority are permanently installed in hospitals and medical practices. EXAMION X-AQS software, which has been developed in-house, for unit control, image processing, diagnostics and archiving, standardises control and ensures an efficient workflow. Our product portfolio encompasses digital radiography, digital image processing as well as mammography and X-ray therapy.

We support our customers with more than 150 employees throughout Germany and in four European sites in Belgium, Poland, Portugal and Switzerland. Worldwide we are working with an ever-growing network of service and sales partners.

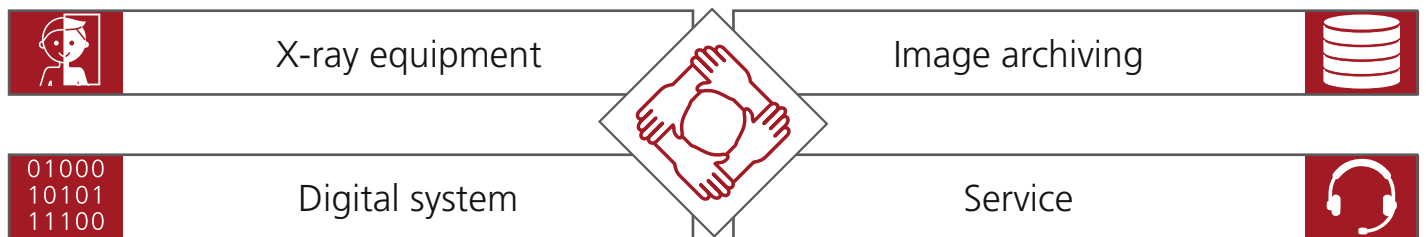

Benefit from years of experience



Contact

Head office Germany

EXAMION GmbH
Erich-Herion-Str. 37
70736 Fellbach
Germany
www.examion.com

 0711 120 002 - 0
 0711 120 002 - 22
 vertrieb@examion.com



Certified partner of EXAMION